

Manufacturer's Declaration as per EU-Directives

Page 1 of 2

The manufacturer	BRAY Armaturen & Antriebe Europa, D47807 Krefeld
declares for the product:	for Butterfly valves all Series 2[.]& Series 3[.] : Series 20/21 (2 body-halves and one-piece disc & shafts) Series 22/23 (with PTFE-liner) Series 30/31/32/33/35/36 (one-piece body) Series S3A (Double Flanged body) <ul style="list-style-type: none"> • manually operated valves • with electric, pneumatic, hydraulic actuator • with bare shaft for actuator assembling later
These products meet requirements of the following European Directives as follows: Pressure Directive 97/23 EG (PED): When Art 3 Clause 1.3 or Art. 3 Clause 3 of the Directive apply: A conformity with this clause of PED is declared. The instructions no. OM0003E for the actuator and the relevant instruction for the valve shall be observed. Machinery Directive 2006/42 EG (MD) An butterfly valve is a not complete machine only within the meaning of the European Machinery Directive 2006/42 EC and is destined to be installed at a pipe system – both together then are a complete machine within the meaning of this European Directive. For the customer's risk analysis the Table at page 2 of this Declaration lists up some requirements of the MD in relation to the valve-actuator unit. The operation instructions no. OM0003E for the valve and the relevant instruction for the actuator shall be observed. In relation to the Directives above shall be observed by the user: <ol style="list-style-type: none"> 1. The user shall observe the „Valve destination“ as defined in the <Instruction for RESILIENT SEATED BUTTERFLY VALVES OM0003E > and shall observe all safety advices that may be relevant at use. Disregard of this advice can invalidate this declaration. 2. The commissioning of a valve-actuator unit is not permitted as long as the conformity of the pipe system into which this unit is installed with all relevant European Directives is not yet declared by the person or institution responsible. The manufacturer BRAY has made and documented all necessary risk analysis – the responsible person is Mr. Franz Ritzberger at BRAY Armaturen & Antriebe in Krefeld, Germany. 	
Krefeld, den 02.03.2011 <div style="text-align: center;">  _____ Ki </div>	
The start-up of an actuator/valve unit is only permitted after the valve has been properly assembled with the pipe section – this only prevents the danger of physical injury of the personnel.	

Standards applied:

EN 593 EN 12100	Metallic Butterfly Valves Safety of machinery – General
----------------------------------	--

Type description & technical data:

BRAY-catalogue <Series 2[.] & Series 3[.]>

<i>Manufacturer's Quality Management System</i> ISO 9001:2008	<i>Register-N° and Name of the notified body</i> Bureau Veritas, Id. number 0062
---	--

Operating Instructions for Resilient Seated Butterfly valves

Manufacturer's Declaration as per EC-Directives Page 2 of 2

Requirement EC 2006/42/Annex I	<p>for Butterfly valves all Series 2[.]& Series 3[.] :</p> <p>Series 20/21 (2 body-halves and one-piece disc & shafts) Series 22/23 (with PTFE-liner) Series 30/31/32/33/35/36 (one-piece body) Series S3A (Double Flanged body)</p> <ul style="list-style-type: none"> • manually operated valves • with electric, pneumatic, hydraulic actuator • with bare shaft for actuator assembling later
1.1.1, g) Valve destination	See original installation and service instruction " OM0003E "
1.1.2.,c) foreseeable misuse	See original installation and service instruction " OM0003E "
1.1.2.,d) protecting measures for personnel	Same as the pipe section into which the valve is installed.
1.1.2.,e) accessories for maintenance	No special tools are necessary.
1.1.3 material in contact with the fluid	The material of wetted parts (valve body or body liner and disc) in contact with the fluid is specified in the order acknowledgement and/or on the valve's marking. The relevant risk analysis is the responsibility of the user.
1.1.5 handling	See installation and service instruction " OM0003E "
1.2 and 6.2.11 control system	Is the responsibility of the user in combination with the instruction of the actuator.
1.3.2 withstand to stresses	For parts under pressure: See declaration of conformity to the PED 97/23/EC For functional parts: Ensured at contractual use of the valve.
1.3.4 sharp edges or angles	Requirements fulfilled.
1.3.7/.8 risks related to moving parts	Requirements are fulfilled at contractual use of the valve. No maintenance or service is allowed when the valve is pressurized and/or it is connected to the control system.
1.5.1 – 1.5.3 energy supply	In the responsibility of the user in combination with the instruction of the valve.
1.5.7 -explosion	☞-protection may be necessary. This shall be confirmed by BRAY in the order acknowledgement.
1.5.13 emission of dangerous substances	Not applicable at not dangerous compressed fluids.
1.6.1 maintenance	See installation and service instruction no. " OM0003E "
1.7.3 marking	Valve: see original installation and service instruction no " OM0003E " Actuator: see actuator instruction
1.7.4 service instruction	See original installation and service instruction no. " OM0003E " and actuator instruction at standard actuator destination. At any special application additional notes and warnings may be necessary but are in the responsibility of the user.
Requirements from Annex III	The valve is not a complete machine but a not complete machine only. No CE marking for conformity with the directive 2006/42/EG.
Requirements from Annexes IV, VIII & XI	Not applicable.

Requirements as per EN 12100	
1. Scope	Basis for the analysis is the Product Standard EN 593: <Metallic butterfly valves>. <i>Note:</i> <i>For the requirements as per clauses 4 to 6 of EN 12100 it is assumed that the user has made a risk analysis for the valve/actuator unit installed into the pipe section under the service conditions– such analysis is not possible for BRAY.</i>
3.20, 6.1 inherent design	The valve has been designed at the principles of <inherent safe design>.
Analyse as per clause 4, 5 and 6	The knowledge of documented malfunctions and misuse at the manufacturer BRAY as per ISO 9001 are the basis of this instruction.
5.3 Limits of the machine	The limits of the valve are defined as per clause A2 <Valve destination> - and the limits of the valve/actuator interface as well.
5.4 Decommissioning, waste management	Not in the responsibility of the manufacturer BRAY
6.2.2 Geometric factors	The valve shell (body, covers) enclose all moving parts of the valve: no risk at use as defined in clause A2 of this instruction OM0003E.
6.3 Technical protective devices	not applicable.
6.4.5 Instruction	Valves with actuator operate automatically after connection to the plant control system. Necessary information for service and maintenance are included in section C of this instruction OM0003E.

Original-installation instruction for centric butterfly valves with service / maintenance instruction and technical Annex

for a valve as <not complete machine> as per European Machinery Directive 2006/42/EG
and per European Pressure Directive 97/23/EG

INDEX	Page
Manufacturer's Declaration as per EC-Directives	1
A) General	
A1 Pictograms	4
A2 Valve Destination	4
A3 Marking of the valve	5
B) Installation and functional check	
B1 Important safety warnings at installation	5
B2 Transport und storage	5
B3 Precondition to install a valve	5
B4 Steps at installation	6
B5 Pressure test of the pipe system	7
B6 Additional information Valve disassembling valve from the pipe section	7
C) Service and maintenance	
C1 Important safety warnings at service and maintenance	8
C2 Commissioning	8
C3 Maintenance	9
C4 Troubleshooting	9
D) Technical Annex & Valve Data	
D1 Technical specification for all Series	9
D2 Pressure-/Temperature limits	9
D3 Drawings / material for Butterfly valves Series 20/21	10
D3 Drawings / material for Butterfly valves Series 30/31	11
D3 Drawings / material for Butterfly valves Series 3A	12

More information

This manual, BRAY-catalogue-pages and other information – even in other language – may be asked from sales@bray.de or from

BRAY Armaturen & Antriebe Europa
Europark – Fichtenhain A , 13b · D-47807 Krefeld
Email: sales@bray.de
Tel: +49 2151 5336 0
Fax: +49 2151 5336 242



A General

This instruction may support the user to store, install, start-up, use and maintain BRAY-butterfly valves all Series 2[.]& Series 3[.] with a manual, electric or pneumatic/hydraulic actuator.

The manufacturer's instruction of the actuator and the instructions of the plant control system shall be observed accordingly by the user.

A1 Pictograms

Warnings and notes of this manual are marked with pictograms:

 xxxxx	Danger / Warning Points out a dangerous situation which may cause personal injuries or death.
	Advice Has to be respected
	Information Information useful to follow

If these notes and warnings are not respected by the user, dangerous situations may occur and may invalidate the warranty of the manufacturer.

A2 Valve destination

A centric BRAY-butterfly valve (i.e. **Series 20/21/22/23, Series 30/31/32/33/35/36, Series 3A**) conforms to EN 593 <metallic butterfly valves> and to ANSI B16.34 <Valves with flanged, welded and screwed ends> and is exclusively destined to let pass or shut off media in the allowable pressure and temperature range.

This pressure and temperature range is defined in Annex D2 – in relation to the body seat sealing material (i.e. EPDM, Buna-N, FKM, PTFE).

All requirements of clauses B1 and C1 <Important information for the user> shall be observed

Note

Valves of these Series may be used in OPEN- or CLOSED-position. If a butterfly valve shall be used for control service the flow conditions shall be agreed between BRAY and the customer/user.

A3 Marking of the valve

Each valve supplied is marked as follows:



Valve marking (example)

The marking shall not be damaged or covered (do not paint over!) to permit the valve identification if necessary.

B Installation and functional check



This instruction includes safety recommendations for foreseeable risks at installation into a pipe (and control) system.

The user is responsible to complete this instruction with warning notes for system-specific aspects. All requirements of the system shall be observed.

B1 Important safety warnings at installation



- Installation shall be performed by qualified personal. Qualified are those persons who, due to experience, can judge the risks and execute the work correctly and who are able to detect and eliminate possible risks.
- A valve shall be assembled into the pipe system as supplied by BRAY – any modification without approval of BRAY is forbidden and determines the manufacturer's liability.
- The valve marking shall fit to the plant system characteristics
- see clause A3 <valve marking>.



**Danger
jamming
one's
hand**

- A butterfly valve installed as an end closing-off of a pipe section under pressure shall be equipped with a blind flange or cover to prevent hazardous leakage to outside.
- *A valve not properly installed in a pipe section:* :
Danger of jamming one's hand or fingers between valve body and disc: Do not operate a valve not capped by the pipe system!
Any actuating of a valve not installed is the full responsibility of the user.

B2 Transport and storage

The valve – and valve/actuator units as well – shall be shipped and stored with care.

- Valve/actuator units shall be in its protective packing. Store units >25kg on a pallet for easy handling.
- Handle valve (or valve and actuator units) with care in its original packaging and protect it from harsh environmental conditions, such as dirt, debris and humidity.



If a hoist shall be used to handle a valve or a valve/actuator unit, fix the lifting devices at the valve body, not at the handwheel.

A lifting device may be fixed at an actuator if it is much heavier than the valve.



ISO 2230 specified store conditions for elastomeric parts and limits the storage time.

- Protect specifically soft rubber- or PTFE-lined ends of a butterfly valve from contact with sharp-edged parts or other rough surfaces.
- A butterfly valve is supplied in slightly open position and shall be stored accordingly. Do not operate the valve.
- Unpack a valve or valve/actuator unit not earlier than just before installation.

B3 Precondition to install the valve

- Ensure to observe the <Valve destination> specified in clause A2 and the valve liner and disc materials to be suitable for the fluids in the plant – see the relevant valve markings in clause A3 and the pressure/temperature limits specified in Annex D2.
- The <mating surfaces> of the pipe flanges shall be exactly plane and smooth and free of grooves.
- As a standard the valve is supplied with handwheel or lever or an actuator ready for connection to the plant control system.
- The valve is supplied in almost closed position and shall be installed accordingly the protect the disc border from damage at installation: Maintain this supply position at transport and installation.



Operating Instructions for Resilient Seated Butterfly valves

	<i>A gear or actuator supplied is adjusted for the service condition „OPEN“ and „CLOSED“: Do not change this adjustment as long as the valve is tight.</i>
---	--



- When a valve is supplied without actuating device take care to install it in closed position and do not operate a bare shaft.
- Ensure the connecting pipe having sufficient clearance for the disc pivoting 90°.
- The flanges of the connecting pipe shall fit to the valve dimensions and shall have parallel connecting surfaces.

B4 Steps at installation

- Take of protecting caps or packaging from the valve – if any.
- The valve design is symmetric and it can be installed in any position into the pipe section – but the actuating device (lever, gear or actuator) should not be installed under the valve to prevent corrosion by shaft leakage. If possible, install the valve shaft in horizontal position.
- When an actuator bigger than the valve shall be installed in horizontal position of the valve, the plant supervisor shall check and decide if this actuator shall be supported in site.

	<i>The pipe section shall be free of foreign particles at installation, before the valve is closed for the 1st time::</i> To prevent leakage at the disc seal, inspect and be sure, that the valve inside, the pipe waterway at both adjacent pipe insides are free from dirt, rust, pipe scale, welding slag and any other foreign material – for flushing see text below.
	<i>Do not use gaskets at then flanged connection:</i> The elastic or PTFE-lining of the valve body is the necessary flange seal as well. Fasten the flange bolting up the metallic contact of valve body and connection pipe circumference all around.
 Danger jamming one's hand	<i>Take special care at a pneumatic valve actuator <fail safe with spring to open>:</i> This <fail safe>-actuator shall be closed temporarily during installation: Take care to keep the valve 100% closed at set-in and centring at the connecting pipe flanges. Do not disconnect the temporary pressure supply until the flange bolting is correctly fastened as described above.

- At installation into an existing pipe system be sure, that the gap between the 2 pipe flanges has sufficient clearance to protect especially the valve body sealing surfaces from damage
Then centre the valve exactly and fasten the flange bolting crosswise in little steps.
- To connect an actuator the relevant manufacturer's instruction applies.

	<i>Valve with electric actuator only:</i> Check and be sure that the signal of the limit switch stops the valve in the CLOSED and OPEN end-positions . A signal of the torque switch may be used as a failure-message . More instruction is given in the actuator manual.
 Danger	Defaults of signals and signalisation could mean danger for the health of the user and/or cause damage in the piping system

- Last step of the installation (preferably after the pipe section flushing):
A manually operated valve must be operated with normal hand force for the full 90°-stroke.
Valve with actuator: Make a functional test with the signals of the plant control system: Open and close the valve to the tight position and check the correct function and signalisation of the limit switches (if any).
At any trouble see clause 7 <Trouble shooting guide>.
- Then open the valve to allow the filling of the pipe system.
- At any failure malfunction refer to clause C4 <Troubleshooting>.

B5 Pressure test of the pipe system

The valve has been pressure tested by the manufacturer as per EN12266-1 or ISO 5208. Observe at the pipe system pressure test to prevent functional overload of the disc:

- **valve in OPEN position:** The test pressure shall be limited to **1,5 x (PN or PS)** – see valve marking. (*PS = maximal admissible pressure at 20°C*).
- **valve in CLOSED position:** The test pressure shall be limited to **1,1 x (PN or PS)**.
- In case of leakage, observe clause 7 <Troubleshooting>.

B6 Additional info: Valve disassembling from the pipe section

Observe the same safety measures as for the pipe section and for the electric/pneumatic plant control system:

- (*if any*) Interrupt the pressure and control supply permanently.
- Open the valve and drain and discharge the pipe section.
- Loosen the flange connection and disassemble the valve – take care not to damage the valve lining.
- At (temporary) storage observe clause B2 <Transport and storage>.



C) Normal service and inspection

As per European Directives 97/23/EC (PED) and 2006/42/EC (MD) the layout engineer shall make a risk analysis for the pipe system. The manufacturer BRAY supplies the following documents for this task:

- This installation and service instruction,
- the initial <Manufacturer's Declaration to EC-Directives>.

	<p><i>This instruction includes safety notes for industrial application for any foreseeable risk at use of the valve.</i></p> <p>It is the responsibility of the user/layout engineer to complete this instruction with warning notes for plant-specific risks.</p>
---	---

C1 Important safety warnings at service and maintenance

	<ul style="list-style-type: none"> • Installation shall be performed by qualified personal. Qualified are those persons who, due to experience, can judge the risks and execute the work correctly and who are able to detect and eliminate possible risks. • The valve function shall correspond to the <Valve destination> as specified in clause A1 and the service conditions shall be in line with the valve marking see clause A3 • The risk to touch a hot valve surface depends from the fluid temperature only – this is the user's responsibility and cannot be anticipated by BRAY. • A valve shall have been assembled into the pipe system and shall be used at service as supplied by BRAY – any modification without approval of BRAY is forbidden and determines the manufacturer's liability. • A butterfly valve installed as an end closing-off of a pipe section under pressure shall be equipped with a blind flange or cover to prevent hazardous leakage to outside.
 Danger	<ul style="list-style-type: none"> • <i>When the pipe section is pressurized:</i> Do not unscrew a cover from the valve body or the pipe flange bolting. • <i>A valve not properly installed in a pipe section: :</i> Danger of jamming one's hand or fingers between valve body and disc: Do not operate a valve not capped by the pipe system! Any actuating of a valve not installed is the full responsibility of the user.

C2 Commissioning

A valve closes clockwise and opens anti-clockwise.

To operate a lever or handwheel normal manual force is sufficient. It is not permitted to use extension levers to increase the torque.

Actuated valves shall be operated by the plant control system. The adjustment of the actuator shall not be changed as long as the valve operates correctly.

Butterfly valves are maintenance-free at normal service conditions – but it is proposed to

- operate every 3 or 4 months a valve remaining permanently in the same position,
- *Series 20/21/22/23 only:*
Check the bolting of the body halves to remain correctly fastened – the necessary torque see Table in clause C4.

C3 Maintenance

Regular maintenance is not required for valves, but at any examination of the line section no leakage shall occur at the valve. In such cases observe section C4 <troubleshooting>.

Such leakage inspection shall be done regularly in case of service condition at the upper limits of pressure and/or temperature.

C4 Troubleshooting

Kind of fault	all Series: Measures																					
Leakage at the pipe flange or at a cover flange connection	Tighten the gasket by the flange bolting. <i>If this is in vain:</i> Replace the body liner of the valve. Observe clause B1 <Special danger..> and order a new liner from BRAY.																					
Leakage at the connection of the body halves or body cover (if any)	Fasten the body halves bolting crossover in little steps with the following torque: <table border="1" style="margin-left: auto; margin-right: auto;"> <thead> <tr> <th style="text-align: center;">thread</th> <th style="text-align: center;">M8</th> <th style="text-align: center;">M10</th> <th style="text-align: center;">M12</th> <th style="text-align: center;">M16</th> <th style="text-align: center;">M20</th> <th style="text-align: center;">M24</th> </tr> </thead> <tbody> <tr> <td></td> <td style="text-align: center;">5/16"</td> <td style="text-align: center;">3/8"</td> <td style="text-align: center;">1/2"</td> <td style="text-align: center;">5/8"</td> <td style="text-align: center;">7/8"</td> <td style="text-align: center;">1"</td> </tr> <tr> <td style="text-align: center;">max.torque [Nm]</td> <td style="text-align: center;">22</td> <td style="text-align: center;">42</td> <td style="text-align: center;">75</td> <td style="text-align: center;">175</td> <td style="text-align: center;">350</td> <td style="text-align: center;">600</td> </tr> </tbody> </table> <i>If this is in vain:</i> Replace the body seal. Observe clause B1 <Special danger..> and order a new liner from BRAY.	thread	M8	M10	M12	M16	M20	M24		5/16"	3/8"	1/2"	5/8"	7/8"	1"	max.torque [Nm]	22	42	75	175	350	600
thread	M8	M10	M12	M16	M20	M24																
	5/16"	3/8"	1/2"	5/8"	7/8"	1"																
max.torque [Nm]	22	42	75	175	350	600																
Leakage at the shaft seal	Replace the body seal – if the disc sealing surface (=outside border) is damaged, replace the disc as well.																					
Leakage at the disc in closed position	Observe clause B1 <Special danger..> and order a new liner from BRAY. At valve Series 2[,] (=2-halves body design) fasten the body halves bolting crossover as described above.																					
Malfunction																						

Order spare parts from BRAY with all information from the valve marking – see clause A3

D) Technical Annex & Valve Data

Note:

This clause is no integral part of the „Original Einbau- und Betriebsanleitung“ but an extract from the BRAY catalogue <Butterfly Valves>. More details may be found in these documents.

D1 Technical Specification for all Series Resilient Seated Butterfly valves

The valves conform to

- ▶ EN593: <Butterfly valves with bodies of metallic materials>
- ▶ ANSI B16.34 <Valves with flanged/welded and screwed ends>

D2 Pressure-/Temperature limits

The body liner in the valve limits the maximum service temperature of the fluid to:

Pressure all Series:	PS _{max} PN6	PS _{max} PN10	PS _{max} PN16	PS _{max} class 150
	6 bar	10 bar	16 bar	150 lbs/sq.inch
Valve liner material				
EPDM	121 °C	121 °C	121 °C	121 °C
Buna-N	100 °C	100 °C	100 °C	100 °C
FKM	150 °C	150 °C	150 °C	150 °C
PTFE *)	200 °C	200 °C	200 °C	200 °C

*) *Note:*

*At the upper limit of the maximum admissible temperature and/or pressure it may be more favourable to choose the double-excentric butterfly valve Series 40 or Series 45 – specifically at frequent actuation.
See Bray catalogue pages Resilient Seated Butterfly valves*

D3 Drawings / Material Butterfly valve Series 20/21

For all valve series see drawings & part lists in the BRAY catalogues <Butterfly valves>

Butterfly valve Series 20

COMPONENTS

No.	Qty.	Description
1	1	Body
2	1	Seat
3	1	Disc/Stem
4	1	Stem Seal
5	1	Stem Bushing
6	1	Body Bolt

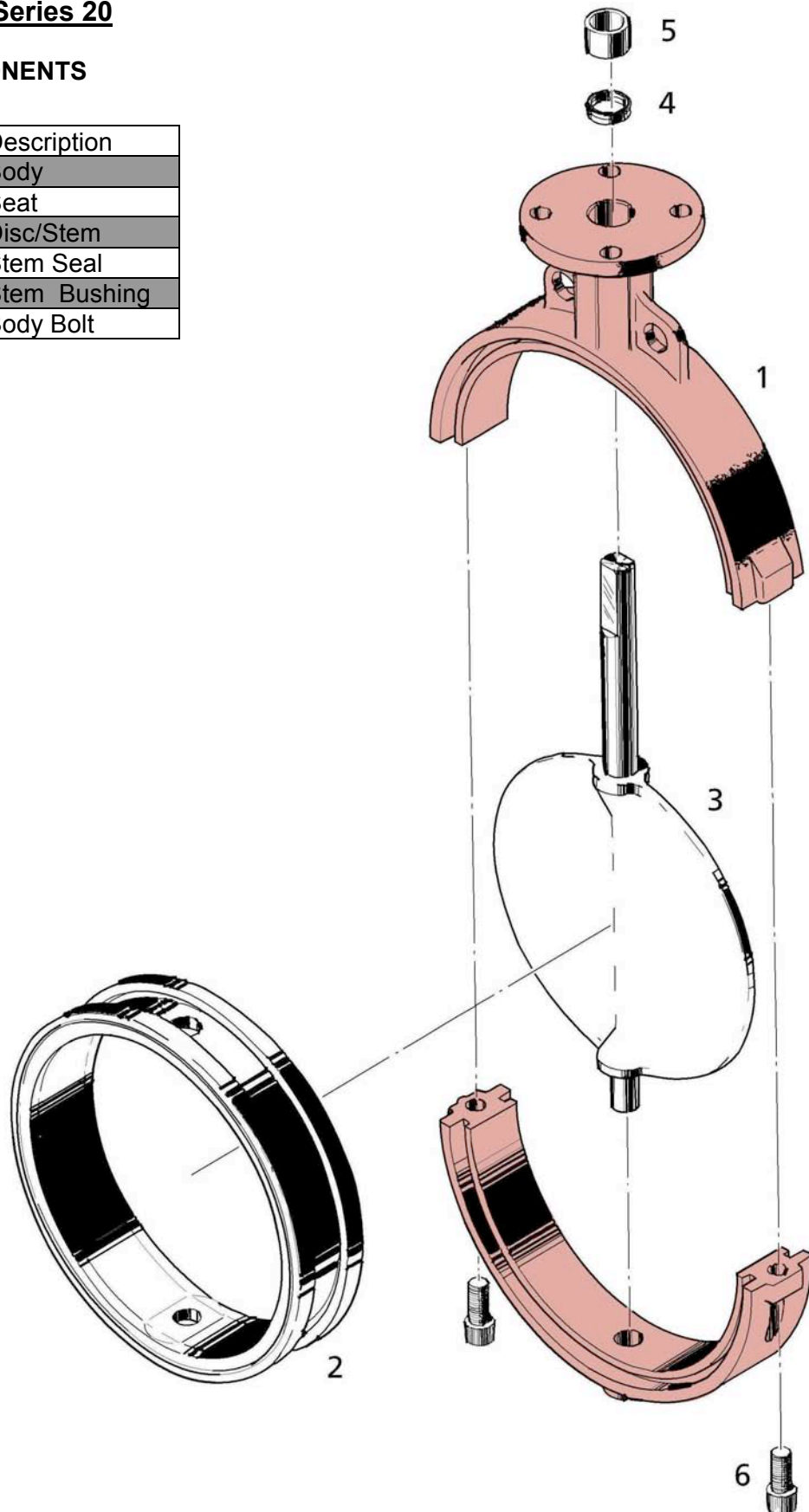

D3 Drawings / Material Butterfly valve Series 30/31

For all valve series see drawings & part lists in the BRAY catalogues <Butterfly valves>

Butterfly valve Series 30

COMPONENTS

No.	Qty.	Description
1	1	Body
2	1	Seat
3	1	Disc
4	1	Stem
5	1	Stem Seal
6	1	Stem Bushing
7	2	Stem Retainer
8	1	Thrust Washer
9	1	Retaining Ring

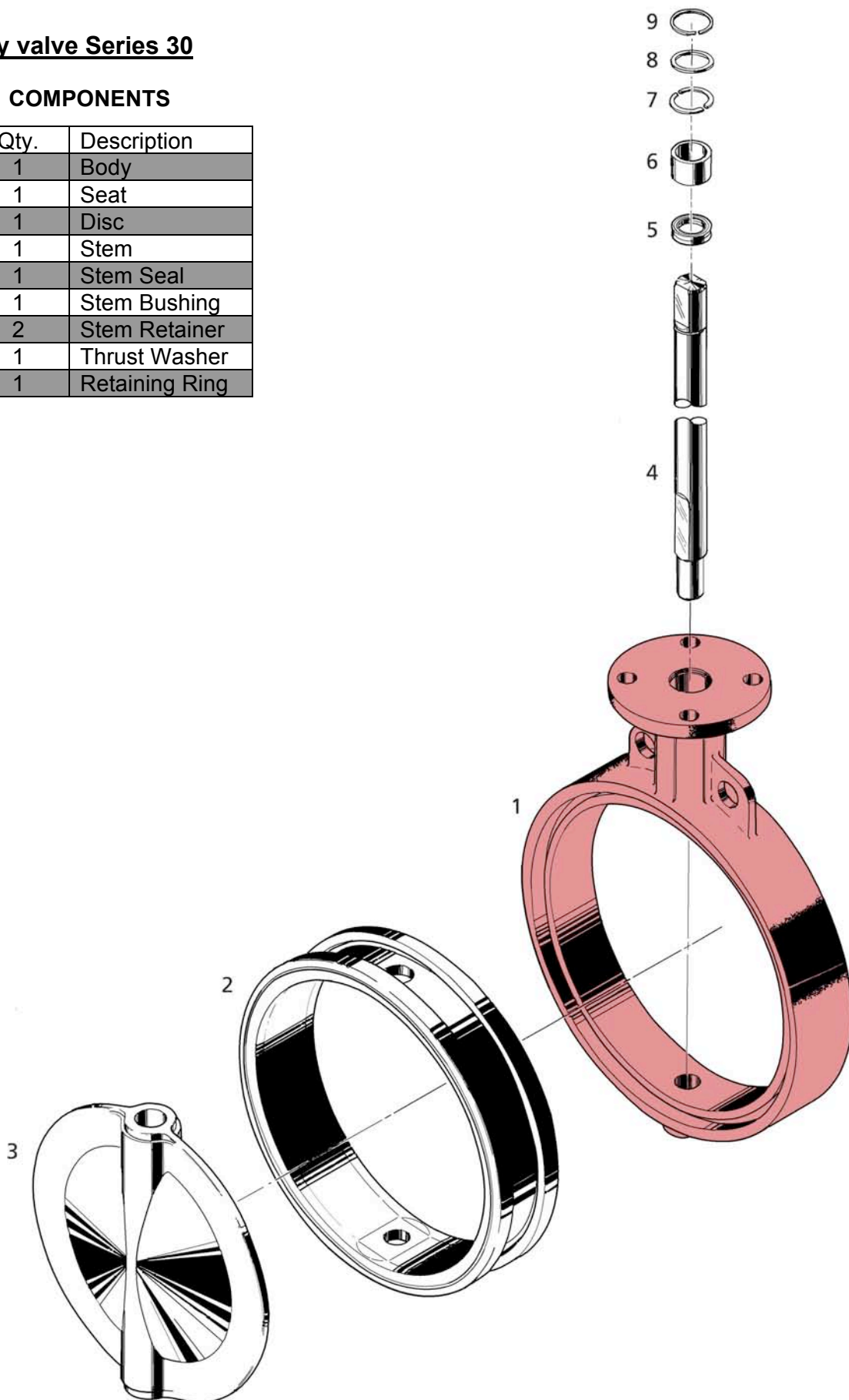

D3 Drawings / Material Butterfly valve Series 3A

For all valve series see drawings & part lists in the BRAY catalogues <Butterfly valves>

Butterfly valve Series 3A

COMPONENTS

No.	Qty.	Description
1	1	Body
2	1	Seat
3	1	Disc
4	1	Stem
5	1	Stem Seal
6	1	Stem Bushing
7	2	Stem Retainer
8	1	Thrust Washer
9	1	Retaining Ring

